

EDE1204 Bi-Polar Stepper Motor IC

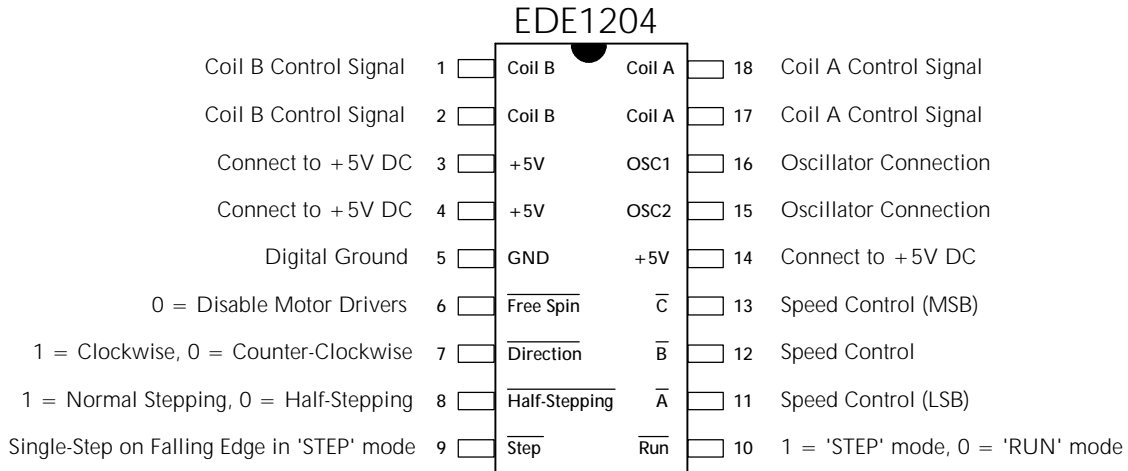

The EDE1204 Bi-Polar Stepper Motor IC is a 5 volt, 18 pin package designed to control a Bi-Polar (4 wire) stepper motor. The EDE1204 is capable of self-clocking in the free-standing 'RUN' mode, as well as external clocking in the 'STEP' mode. In addition, half-stepping and directional control are also available. The TTL-level outputs sequence dual H-Bridges (one per coil) such as the L293 Dual H-Bridge IC or dual H-Bridges made from discrete transistors (see schematics section). The EDE1204 features the ability to change the stepping rate while the motor is stepping and to self-clock an unlimited number of steps in continuous 'RUN' mode. Inputs are TTL/ CMOS compatible.

RUN mode

In the 'RUN' mode, activated by a low on pin 10, the EDE1204 will cause the motor to rotate according to the following parameters:

Direction (pin 7): 1 = clockwise, 0 = counter-clockwise
(If a clockwise command causes counterclockwise rotation of motor, reverse the sequence of the motor's four phase wires.)

Half-Stepping (pin 8): 1 = normal stepping, 0 = half stepping (doubles step resolution)

Speed Control [C,B,A] (pins 13,12,11): these three active-low bits select one of eight rotational speeds. Refer to Tables One & Two below for speed range details.

Note: Throughout this datasheet, "1" refers to +5V, and "0" refers to 0V (Ground).

Table One - Full Step 'RUN' mode speeds*:

Revolutions per second & minute are based upon a 1.8° per step motor.
EDE1204 external clock speed is 4 MHz.

Speed Input (C,B,A)	RPS	RPM
000	.152	9.1
001	.172	10.3
010	.2	12
011	.244	14.6
100	.303	18.2
101	.4	24
110	.606	36.4
111	1.18	70.6

Table Two - Half-Step 'RUN' mode speeds*:

Revolutions per second & minute are based upon a 1.8° per step motor.
EDE1204 external clock speed is 4 MHz.

Speed Input (C,B,A)	RPS	RPM
000	.077	4.6
001	.089	5.3
010	.103	6.2
011	.121	7.27
100	.154	9.2
101	.2	12
110	.303	18.2
111	.606	36.4

* Note: indicated speeds are approximate and may vary with oscillator frequency and other factors. Please verify exact value before using in any speed-critical application.

The following chart depicts revolutions per second for a 1.8° stepper motor, in relation to the three speed selection bits, for both full and half stepping. Please note that the speed increase is nonlinear; i.e. finer speed control is available at slower step speeds. Again, indicated speeds are approximate and will vary with oscillator frequency. Please verify exact value before using in any speed-critical application.

Motor Speed vs. Speed Selection Bits

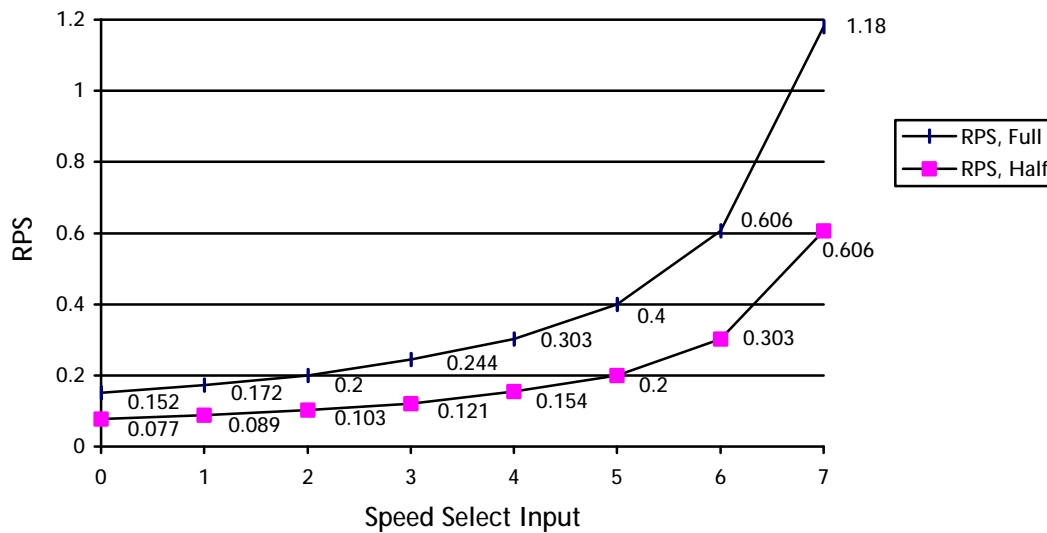

STEP mode

In the 'STEP' mode, an external clock signal is required for each step of the motor. The RUN (pin 10) line must be left high. Each low-going pulse on the STEP (pin 9) line causes a movement of the motor according to the Direction and Half-step pins as specified below:

Direction (pin 7): 1 = clockwise, 0 = counter-clockwise

(If a clockwise command causes counterclockwise rotation of motor, reverse the sequence of the motor's four phase wires.)

Half-Stepping (pin 8): 1 = normal stepping, 0 = half stepping (doubles step resolution)

With the EDE1204 running at an external clock speed of 4 MHz, the 'STEP' pin may be driven at speeds up to 5 KHz, resulting in a motor speed over 1,500 RPM with a 1.8° per step motor. All stepper motors require ramped acceleration to such high RPM rates; do not instantly apply high speed step requests immediately to a stopped motor. Motor type and load will determine maximum acceleration rate. However, ordinary speed ranges (such as the EDE1204's 'RUN' mode speeds) do not require a ramped acceleration.

Free-Spin

Holding the free-spin input (pin 6) low causes the EDE1204 to de-activate both motor coils by placing each wire of a coil at the same voltage. During ordinary operation (step and run modes) the motor is held in position by the 'braking' effect inherent in all stepper motors. Activating this active-low input allows the motor spindle to spin freely without the braking effect. Braking effect is resumed when free-spin input (pin 6) is raised.

Hookup Examples

Warning: As activating both sides of an H-Bridge circuit may cause short-circuit current flow, it is imperative that the two EDE1204 pins labeled 'Coil A' be connected as inputs to one H-Bridge, and the two EDE1204 pins labeled 'Coil B' be connected as inputs to the other H-Bridge.

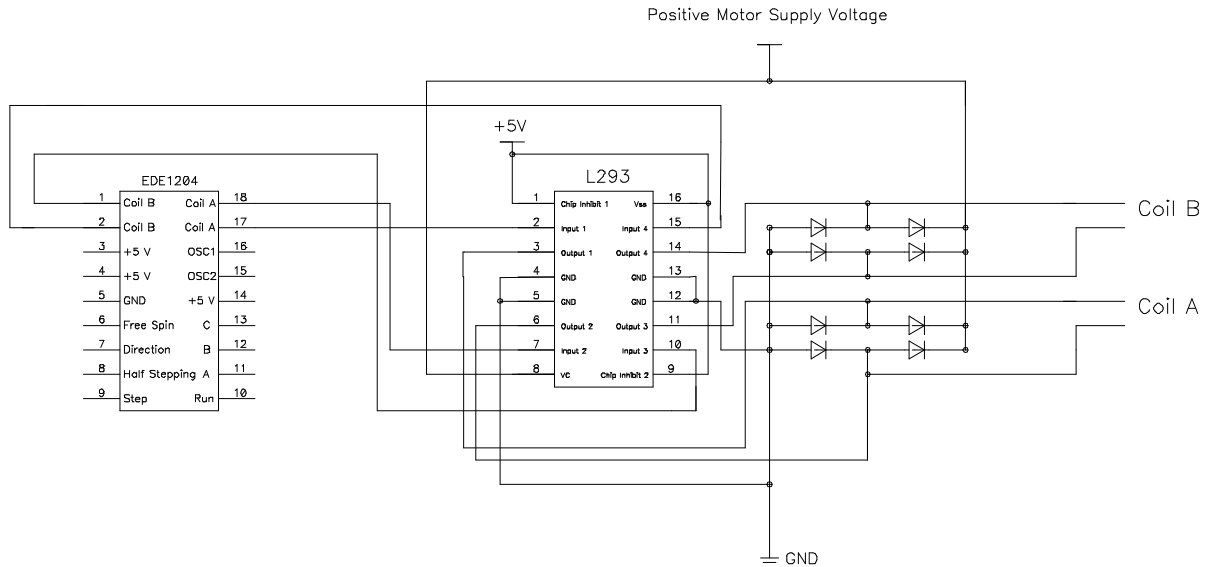

Connection via L293 H-Bridge IC (full EDE1204 schematic not shown)

In this first example, The EDE1204 is paired with a L293 Dual H-Bridge IC. The L293 can supply up to 1A per coil. A variant of the L293, the L293D, includes the output clamping diodes within the IC. This arrangement is ideal for many applications as it provides a two IC drive circuit.

Pinout for the L293 IC is as follows:

- Pin 1: Chip Inhibit
- Pin 2: Input 1
- Pin 3: Output 1
- Pin 4: GND
- Pin 5: GND
- Pin 6: Output 2
- Pin 7: Input 2
- Pin 8: Vc (Collector Supply Voltage)
- Pin 9: Chip Inhibit 2
- Pin 10: Input 3
- Pin 11: Output 3
- Pin 12: GND
- Pin 13: GND
- Pin 14: Output 4
- Pin 15: Input 4
- Pin 16: Vss (Logic Supply Voltage, +5V)

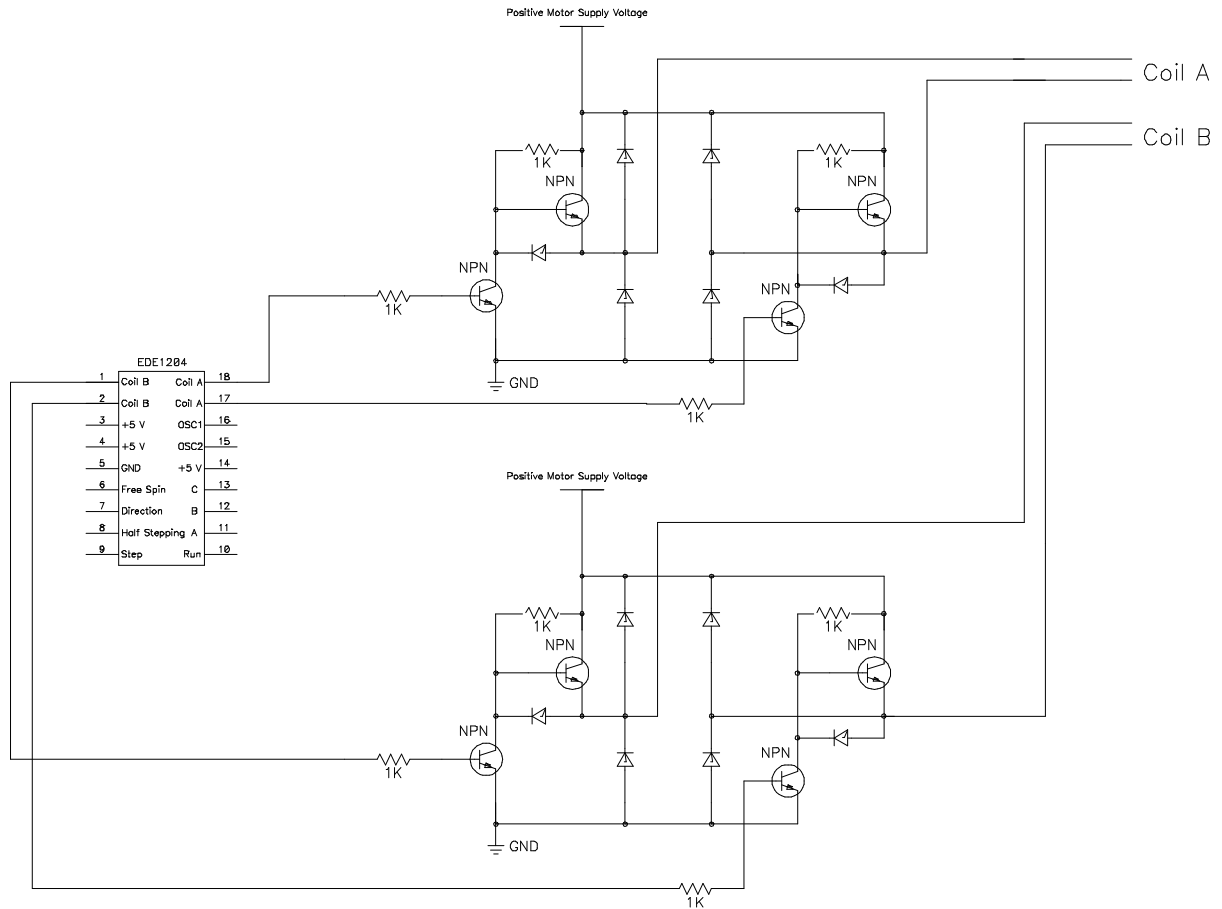

Connection via Eight-NPN Transistor H-Bridge (full EDE1204 schematic not shown)

The above circuit utilizes eight NPN transistors. For low-current applications, inexpensive 2N2222 NPN transistors may be used. For higher currents, higher-capacity transistors may be used. One suitable choice would be ZETEX ZTX690B (high-gain NPN), capable of up to 2A continuous current. (ZETEX Semiconductor's web site is www.zetex.com) If a typical, low-gain power transistor is used, such as the MJE3055T, you may need to modify resistor values due to these transistors' lower current gain. Notice that the four diodes connecting the emitters to the collectors must be capable of carrying the motor coil current, and that the eight clamping diodes must be fast enough for the maximum motor speed to be used. In most instances, a 1N4007 or 1N5408 works well for the four emitter-collector diodes, and a 1N4007 works well for the eight clamping diodes.

One advantage of using all NPN transistors for the drive circuitry is that it lowers the possibility of confusion during board assembly & production. Also, using only eight transistors, it results in a lower production cost than most typical H-Bridge circuits.

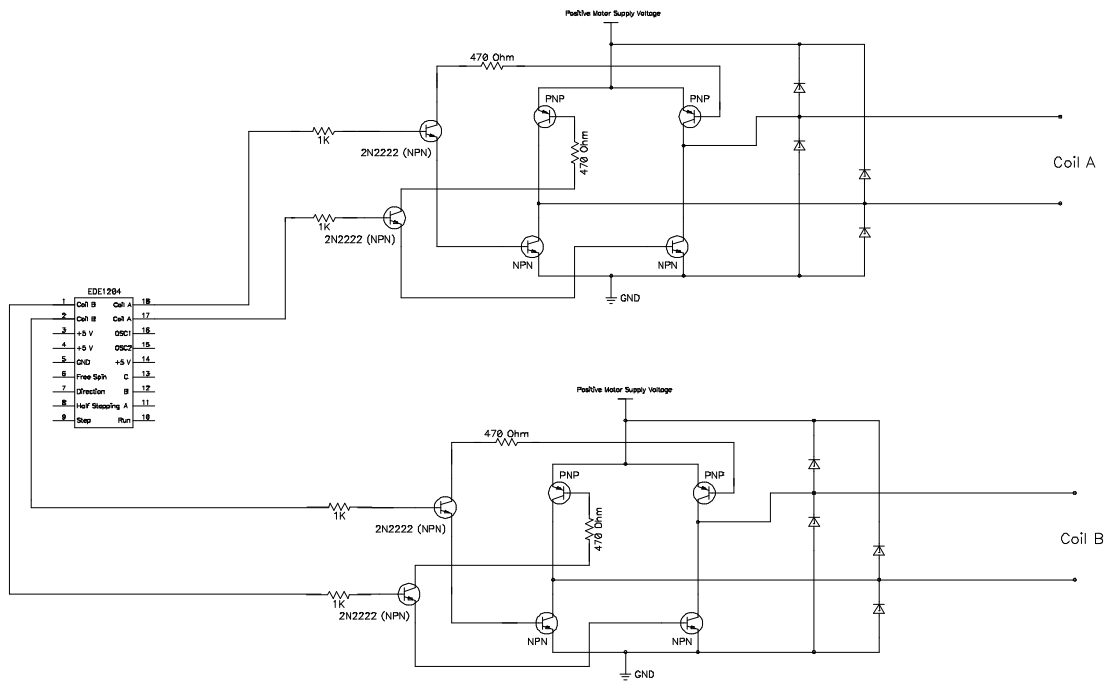

Connection via NPN-PNP Transistor H-Bridge (full EDE1204 schematic not shown)

This classic H-Bridge circuit makes use of matched NPN and PNP drive transistors. Note that four 2N2222 NPN transistors are used to interface between the EDE1204 and the H-Bridge circuit; any small-signal NPN transistor may be substituted.

One suitable choice for the matched NPN-PNP pairs is the ZETEX ZTX690B NPN transistor and ZETEX ZTX790A PNP transistor. These high-gain, high performance transistors are capable of delivering a lot of current in a small modified TO-92 package; up to two Amps per coil can be delivered using this pair (see transistor datasheets for exact figures). Alternately, any other type of NPN-PNP pairs may be used - the choices are seemingly unlimited.

Again, note that with the above circuit the eight clamping diodes must be fast enough for the motor speed you are using.

For further information on the use of the EDE1204 Bi-Polar Stepper Motor IC, or the EDE1200 Unipolar Stepper Motor IC, download a copy of the E-Lab Stepper Motor FAQ containing troubleshooting tips to common problems as well as illustrating the connection of a 555 timer IC to the EDE1204 for variable speed stepping. If you require assistance with your design please do not hesitate to contact us for free engineering design-in assistance.

Although we strive to maintain a high degree of technical accuracy, this document may contain typographical errors or other inaccuracies. We reserve the right to correct any inaccuracy in future editions of this document without notice. This document and examples contained herein are provided 'As Is' without warranty of any kind expressed or implied. This document is to be used for informational purposes only and may not be duplicated for commercial purposes other than by distributors authorized by E-Lab.

ABSOLUTE MAXIMUM RATINGS

Oscillator frequency	4 MHz
Supply Voltage	6.25V
Ambient temperature under bias	-5°C to +125°C
Max. current sunk by output pin	25mA
Max. current sourced by output pin	20mA

STANDARD OPERATING CONDITIONS

Supply voltage	3.0V to 5.5V
Operating temperature	0°C to +70°C

The EDE1204 IC is implemented as firmware on a PIC16C54B microcontroller, manufactured by Microchip Technology, Inc. For a more comprehensive technical summary of this device please refer to the PIC16C54B/04 datasheet (accessible via the E-Lab web site)

IMPORTANT NOTICE

E-LAB Digital Engineering, Inc. (E-LAB), reserves the right to change products or specifications without notice. Customers are advised to obtain the latest versions of product specifications, which should be considered when evaluating a product's appropriateness for a particular use.

THIS PRODUCT IS WARRANTED TO COMPLY WITH E-LAB'S SPECIFICATION SHEET AT THE TIME OF DELIVERY. BY USING THIS PRODUCT, CUSTOMER AGREES THAT IN NO EVENT SHALL E-LAB BE LIABLE FOR ANY DIRECT, INDIRECT, SPECIAL, INCIDENTAL OR CONSEQUENTIAL DAMAGES AS A RESULT OF THE PERFORMANCE, OR FAILURE TO PERFORM, OF THIS PRODUCT.

E-LAB MAKES NO OTHER WARRANTIES, EXPRESSED OR IMPLIED, INCLUDING ANY IMPLIED WARRANTIES OF MERCHANTABILITY OR FITNESS FOR A PARTICULAR PURPOSE.

E-LAB'S LIABILITY IS FOR A PERIOD NO GREATER THAN 90 DAYS FROM DATE OF SHIPMENT BY E-LAB AND IS LIMITED TO REPLACEMENT OF DEFECTIVE PRODUCT. This warranty covers only defects arising under normal use and not malfunctions resulting from misuse, abuse, modification, or repairs by anyone other than E-LAB.

E-LAB'S PRODUCTS ARE NOT AUTHORIZED FOR USE AS CRITICAL COMPONENTS IN LIFE SUPPORT DEVICES OR SYSTEMS WITHOUT THE EXPRESS WRITTEN APPROVAL OF THE PRESIDENT OF E-LAB. Life support devices or systems are those which are intended to support or sustain life and whose failure to perform can be reasonably expected to result in a significant injury or death to the user. Critical components are those whose failure to perform can be reasonably expected to cause failure of a life support device or system or affect its safety or effectiveness.

COPYRIGHT NOTICE

This product may not be duplicated. E-LAB Digital Engineering, Inc. holds all copyrights on firmware, with all rights reserved. Unauthorized duplication of this device may be subject to penalty under state and/ or federal law. EDE1204 and the E-LAB logo are trademarks of E-LAB Digital Engineering, Inc.

CONTACTING US

E-LAB Digital Engineering, Inc.
Carefree Industrial Park
1600 N. State Rte. 291 Hwy. Ste. 330
Independence, MO 64052-0436

Telephone: (816) 257-9954
FAX: (816) 257-9945



www.elabinc.com
support@elabinc.com